



# General Instruments

[Artery Forceps](#)

[Clamps](#)

[Spring Forceps](#)

[Tissue Forceps](#)

[Sponge Holding and Sterilising Forceps](#)

[Other Forceps](#)

[Scissors](#)

[Needle Holders](#)

[Combined Scissor and Needle Holders](#)

[Bag and Towel Clips](#)

[Retractors](#)

[Dissectors and Probes](#)

[Hollow Ware](#)

# Artery Forceps

## Adson Artery Forceps

Box joint, 180mm long

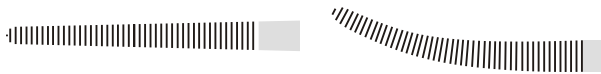
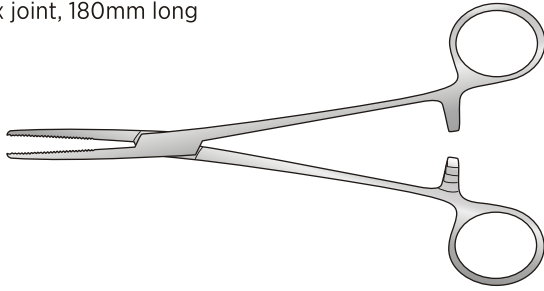

### Serrated jaws

Code	Description
SI-GI/034	Straight
SI-GI/034a	Curved

### 1-2 teeth

Code	Description
SI-GI/034b	Straight
SI-GI/034c	Curved

## Cushing Artery Forceps

Box joint, fine, half serrated jaws, 140mm long

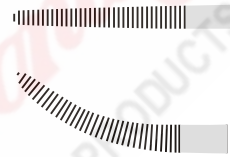
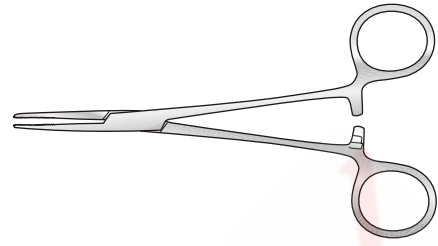

Code	Description
SI-GI/001	Straight
SI-GI/002	Curved

## Cairns Artery Forceps

Box joint, half serrated jaws  
145mm long

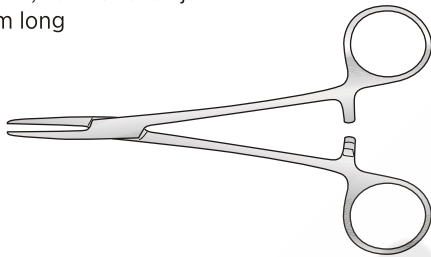

### Serrated jaws

Code	Description
SI-GI/415	Straight

### 1-2 teeth

Code	Description
SI-GI/020	Curved
SI-GI/021	Curved to side

## Dunhill Artery Forceps

Box joint, fine serrations

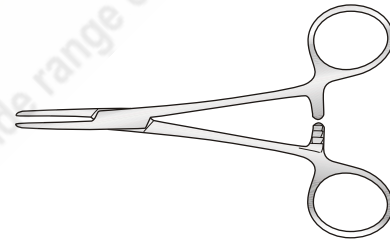

### Straight

Code	Description
SI-GI/065	135mm long
SI-GI/065a	190mm long

### Curved

Code	Description
SI-GI/043	135mm long
SI-GI/468	180mm long

## Crile Artery Forceps

Box joint, serrated jaws

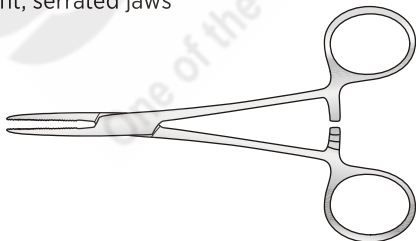

### Straight

Code	Description
SI-GI/014	140mm long
SI-GI/014a	160mm long

### Curved

Code	Description
SI-GI/015	140mm long
SI-GI/015a	160mm long

## Lawson Tait Artery Forcep

Box joint, straight jaw

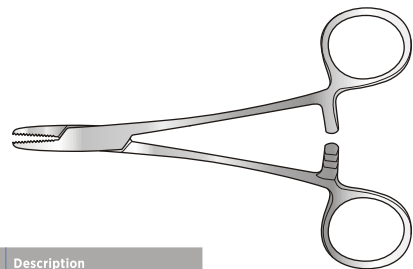

Code	Description
SI-GI/SH5924	140mm long

All images are indicative. Constant R & D may lead us to change the design for improvement

## Halstead Mosquito Forceps

Standard pattern, haemostatic, box joint

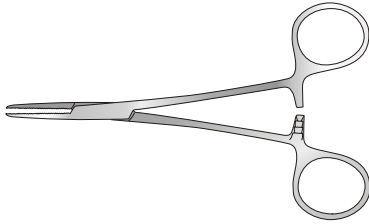

### Serrated jaw

Code	Description
SI-GI/007	Straight 125mm long
SI-GI/008	Curved 125mm long
SI-GI/009	Fully curved 125mm long

### 1-2 teeth

Code	Description
SI-GI/010	Straight 125mm long
SI-GI/012	Straight 190mm long
SI-GI/011	Curved 125mm long
SI-GI/013	Curved 190mm long

### Micro, 100mm long

Code	Description
SI-GI/003	Straight, serrated
SI-GI/004	Curved, serrated
SI-GI/005	Straight, 1-2 teeth
SI-GI/006	Curved, 1-2 teeth

## Kelly Artery Forceps

Box joint, half serrated jaws



### Straight

Code	Description
SI-GI/022	140mm long
SI-GI/023	160mm long

### Curved

Code	Description
SI-GI/024	140mm long
SI-GI/025	160mm long

## Fraser Kelly Artery Forceps Curved

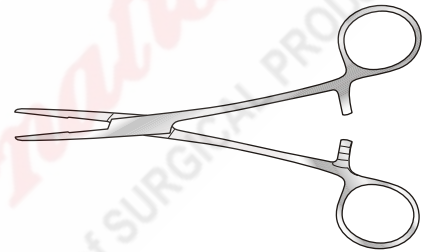

### Straight

Code	Description
SI-GI/468a	180mm

## Heiss Artery Forceps

Box joint, 205mm long

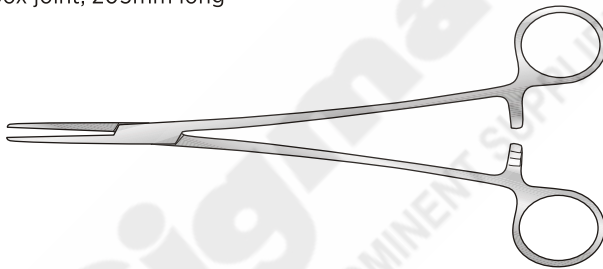

### Serrated jaws

Code	Description
SI-GI/016	Straight
SI-GI/017	Curved

### 1-2 teeth

Code	Description
SI-GI/016a	Straight
SI-GI/017b	Curved

## Kocher Artery Forceps

Box joint, 1-2 teeth

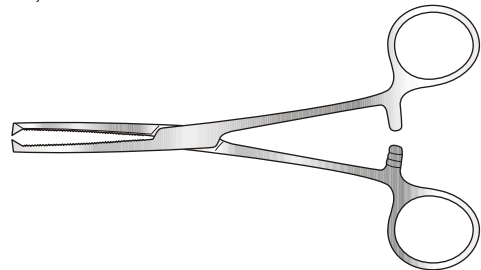

### Straight

Code	Description
SI-GI/052	130mm long
SI-GI/053	150mm long
SI-GI/054	180mm long
SI-GI/055	200mm long
SI-GI/056	230mm long

### Curved

Code	Description
SI-GI/057	150mm long
SI-GI/058	180mm long
SI-GI/059	200mm long
SI-GI/060	230mm long

# Artery Forceps

## Moynihan Artery Forceps

Box joint, half-serrated jaws

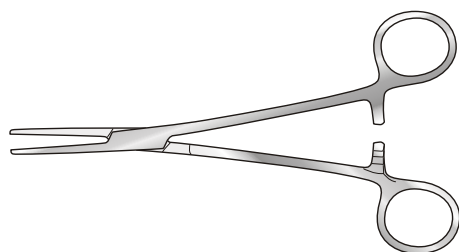

### Straight

Code	Description
SI-GI/018	145mm long
SI-GI/068	180mm long

### Curved

Code	Description
SI-GI/019	145mm long
SI-GI/069	180mm long

## Rochester-Pean Artery Forceps

Box joint

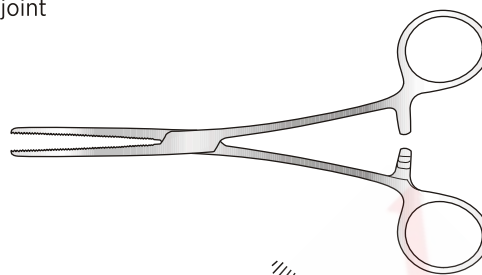

### Straight

Code	Description
SI-GI/044	165mm long
SI-GI/045	190mm long
SI-GI/046	205mm long
SI-GI/047	240mm long

### Curved

Code	Description
SI-GI/048	165mm long
SI-GI/049	180mm long
SI-GI/050	205mm long
SI-GI/051	240mm long

## Roberts Artery Forceps

Screw joint, curved on flat, serrated

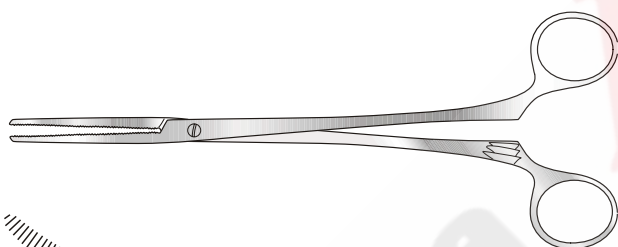

Code	Description
SI-GI/070	230mm long

## Spencer Wells Artery Forceps

Box joint, serrated jaws

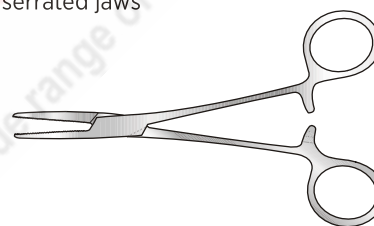

### Straight

Code	Description
SI-GI/035	127mm long
SI-GI/036	152mm long
SI-GI/037	177mm long
SI-GI/038	203mm long

### Curved

Code	Description
SI-GI/039	127mm long
SI-GI/040	152mm long
SI-GI/041	177mm long
SI-GI/042	203mm long

OTHER SIZES AVAILABLE

## Dandy Artery Forceps

Box joint, curved in plane

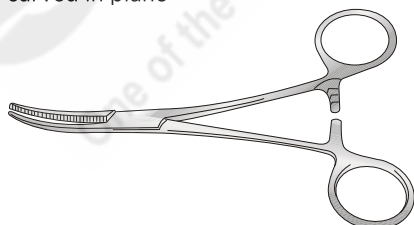

Code	Description
SI-GI/076	140mm long



## Carmalt Angiotribe Forceps

Box joint, atraumatic, light pattern

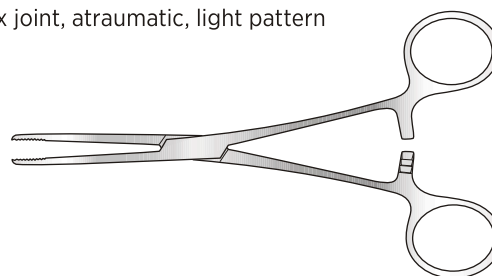

### Straight

Code	Description
SI-GI/062	165mm long
SI-GI/063	200mm long
SI-GI/064	230mm long

### Curved

Code	Description
SI-GI/061	165mm long

All images are indicative. Constant R & D may lead us to change the design for improvement

## DieEenbach Bulldog Clamp

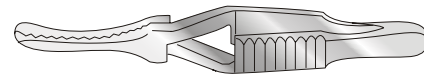
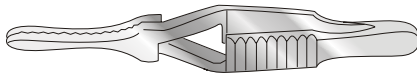

### Straight, serrated

Code	Description
SI-GI/112	1.2mm fine jaw, 40mm long
SI-GI/113	1.2mm fine jaw, 45mm long
SI-GI/108	1.8mm jaw, 30mm long
SI-GI/109	1.8mm jaw, 35mm long
SI-GI/110	2.5mm jaw, 40mm long
SI-GI/111	2.5mm jaw, 45mm long
SI-GI/107	6mm heavy jaw, 60mm long
SI-GI/455	20mm jaw, 75mm long
SI-GI/455a	30mm jaw, 85mm long
SI-GI/455b	45mm jaw, 105mm long
SI-GI/455c	65mm jaw, 120mm long

### Straight, plain

Code	Description
SI-GI/129	1.2mm fine jaw, 40mm long
SI-GI/131	1.2mm fine jaw, 45mm long
SI-GI/121	1.8mm jaw, 30mm long
SI-GI/123	1.8mm jaw, 35mm long
SI-GI/125	2.5mm jaw, 40mm long
SI-GI/127	2.5mm jaw, 45mm long

### Curved, serrated

Code	Description
SI-GI/119	1.2mm fine jaw, 40mm long
SI-GI/120	1.2mm fine jaw, 45mm long
SI-GI/115	1.8mm jaw, 30mm long
SI-GI/116	1.8mm jaw, 35mm long
SI-GI/117	2.5mm jaw, 40mm long
SI-GI/118	2.5mm jaw, 45mm long
SI-GI/114	6mm heavy jaw, 60mm long
SI-GI/456	20mm jaw, 75mm long
SI-GI/456a	30mm jaw, 85mm long
SI-GI/456b	45mm jaw, 105mm long
SI-GI/456c	65mm jaw, 120mm long

### Curved, plain

Code	Description
SI-GI/130	1.2mm fine jaw, 40mm long
SI-GI/132	1.2mm fine jaw, 45mm long
SI-GI/122	1.8mm jaw, 30mm long
SI-GI/124	1.8mm jaw, 35mm long
SI-GI/126	2.5mm jaw, 40mm long
SI-GI/128	2.5mm jaw, 45mm long

## Blalock Bulldog Clamp

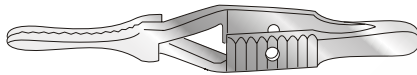

### Serrated, with hole in handle

#### Straight

Code	Description
SI-GI/480	11mm jaw, 38mm long
SI-GI/482	14mm jaw, 48mm long
SI-GI/493	17mm jaw, 60mm long
SI-GI/481	27mm jaw, 70mm long

#### Curved

Code	Description
SI-GI/478	11mm jaw, 38mm long
SI-GI/479	14mm jaw, 48mm long
SI-GI/491	17mm jaw, 60mm long
SI-GI/492	27mm jaw, 70mm long

### Plain, with hole in handle

#### Straight

Code	Description
SI-GI/486	11mm jaw, 38mm long
SI-GI/487	14mm jaw, 48mm long
SI-GI/488	17mm jaw, 60mm long
SI-GI/489	27mm jaw, 70mm long

#### Curved

Code	Description
SI-GI/483	11mm jaw, 38mm long
SI-GI/484	14mm jaw, 48mm long
SI-GI/485	17mm jaw, 60mm long
SI-GI/490	27mm jaw, 70mm long

# Spring Forceps

## Adsons Dissecting Forceps

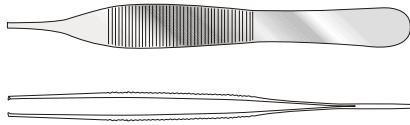

127mm long

Code	Description
SI-GI/257	1-2 teeth
SI-GI/258	Lightweight, micro
SI-GI/259	Serrated
SI-GI/260	Serrated, lightweight, micro

## DeBakey Atraumatic Dissecting Forceps

Straight, atraumatic jaws

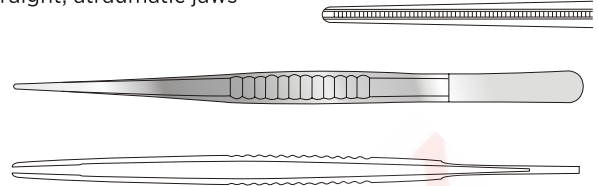

1.5mm

Code	Description
SI-GI/238a	150mm long
SI-GI/240a	240mm long

2.5mm

Code	Description
SI-GI/238b	150mm long
SI-GI/240b	240mm long

## Block End Dissecting Forceps

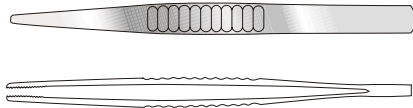

Serrated

Code	Description
SI-GI/255	127mm long
SI-GI/256	152mm long
SI-GI/256a	203mm long

2mm

Code	Description
SI-GI/238	150mm long
SI-GI/241	180mm long

2.8mm

Code	Description
SI-GI/238c	150mm long
SI-GI/240c	240mm long
SI-GI/241c	180mm long

## Dissecting Forceps

Turnover end, serrated jaws

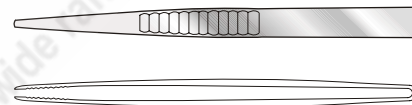

## Bonney Dissecting Forceps

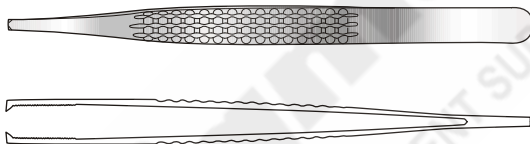

178mm long

Code	Description
SI-GI/267	Serrated, 1-2 teeth
SI-GI/268	1-2 teeth

Code	Description
SI-GI/242	127mm long
SI-GI/243	152mm long

Code	Description
SI-GI/244	178mm long
SI-GI/245	203mm long

## Dunhill Dissecting Forceps

Light, fine serrated jaws



Code	Description
SI-GI/457	145mm long

## Charnley-McIndoe Dissecting Forceps

150mm long

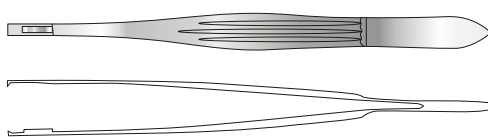

Code	Description
SI-OR/N045a	2-3 teeth

## Fredrick Coole Dissecting Forceps

Extra fine serrated jaws

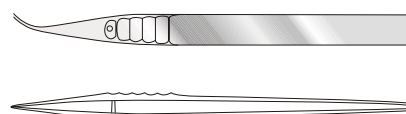

125mm long

Code	Description
SI-GI/066	Straight
SI-GI/067	Curved

All images are indicative. Constant R & D may lead us to change the design for improvement

## Gillies Dissecting Forceps

1-2 teeth

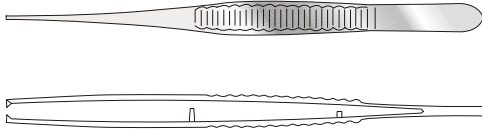

Code	Description
SI-PL/052	152mm long

## McIndoe Dissecting Forceps

152mm long

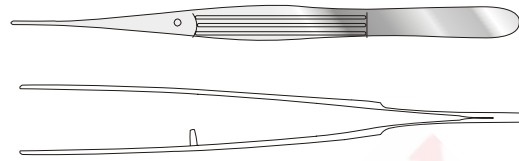

Code	Description
SI-GI/476	Serrated
SI-GI/477	1-2 teeth

## Jackson Burrows Dissecting Forceps

140mm long

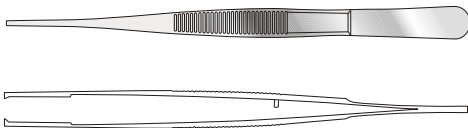

Code	Description
SI-OR/N037	Tongue and groove, 1-2 teeth
SI-OR/N037a	Tongue and groove only

## McIndoe Modified Dissecting Forceps

152mm long, 1mm tip, modified for fine powerful dissection with strong action tip

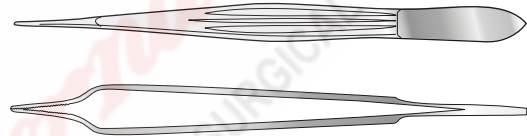

Code	Description
SH/5961	Serrated

## Jean Dissecting Forceps

Serrated jaws, 140mm long

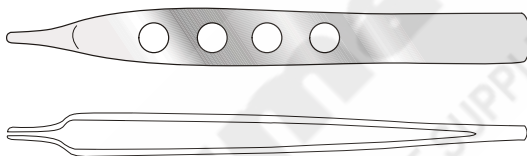

Code	Description
SI-GI/269	Fine
SI-GI/270	1-2 teeth
SI-GI/271	2-3 teeth, 178mm long

## Treves Dissecting Forceps

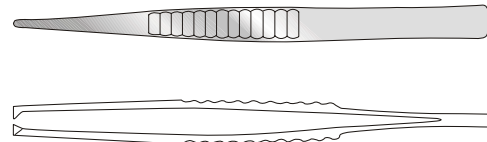

### 1-2 teeth

Code	Description
SI-GI/251	127mm long
SI-GI/252	152mm long

### 2-3 teeth

Code	Description
SI-GI/253	127mm long
SI-GI/254	152mm long

## Lanes Dissecting Forceps

1-2 teeth on serrated jaws, 140mm long

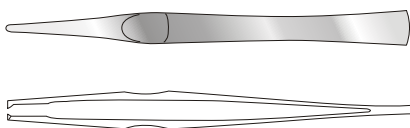

Code	Description
SI-GI/246	127mm long
SI-GI/247	152mm long
SI-GI/248	178mm long

Code	Description
SI-GI/249	2-3 teeth, 178mm long
SI-GI/250	2-3 teeth 203mm long

## Waugh Dissecting Forceps

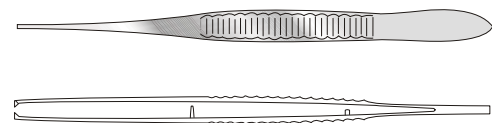

### Fine, serrated

Code	Description
SI-GI/261	152mm long
SI-GI/262	178mm long
SI-GI/263	203mm long

### Fine, 1-2 teeth

Code	Description
SI-GI/264	152mm long
SI-GI/265	178mm long
SI-GI/266	203mm long

All images are indicative. Constant R & D may lead us to change the design for improvement

# Tissue Forceps

## Allis Tissue Forceps

Box joint

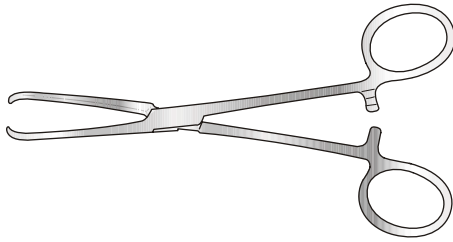

150mm long

Code	Description
SI-GI/272	3-4 teeth
SI-GI/273	4-5 teeth

190mm long

Code	Description
SI-GI/414	5-6 teeth

## Duval Tissue Forceps

Box joint

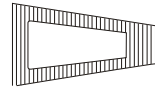
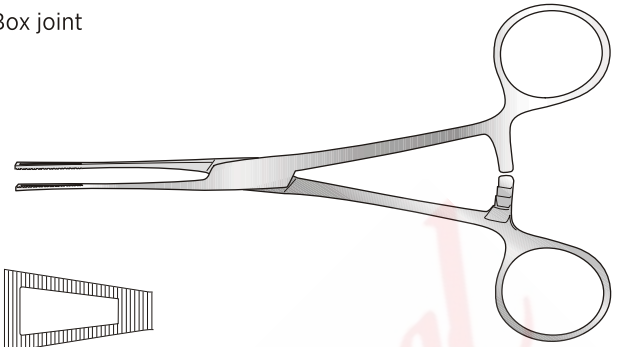

Code	Description
SI-GI/279	13mm wide, 203mm long

## Littlewood Tissue Forceps

Box joint, 2-3 teeth

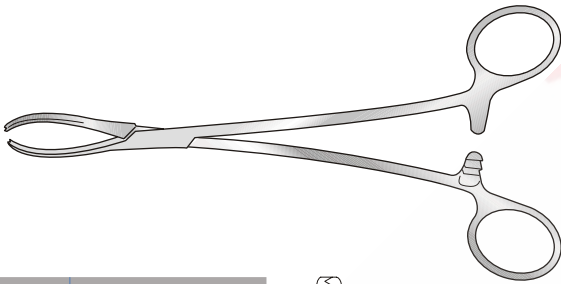

Code	Description
SI-GI/275	190mm long

## Lane Tissue Forceps

Box joint, 1-2 teeth, fenestrated

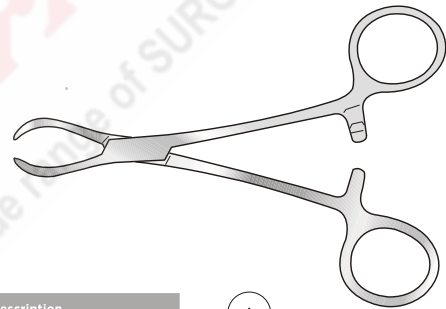

Code	Description
SI-GI/280	127mm long
SI-GI/281	152mm long
SI-GI/282	197mm long

## Babcock Tissue Forceps

Box joint, serrated jaws

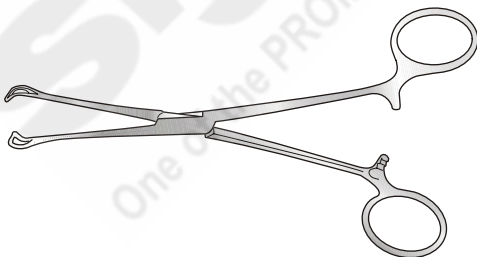

Code	Description
SI-GI/276	160mm long
SI-GI/277	200mm long
SI-GI/278	230mm long

## Rutherford Morrison Tissue Forceps

Box joint

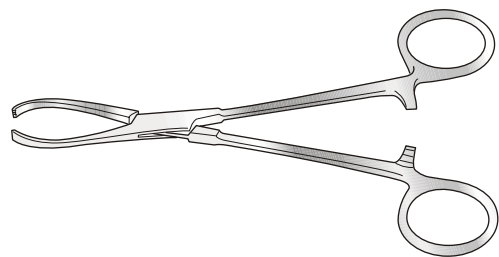

Code	Description
SI-GI/283	4-5 teeth, 152mm long

All images are indicative. Constant R & D may lead us to change the design for improvement



## Shaw Tissue Forceps

Box joint

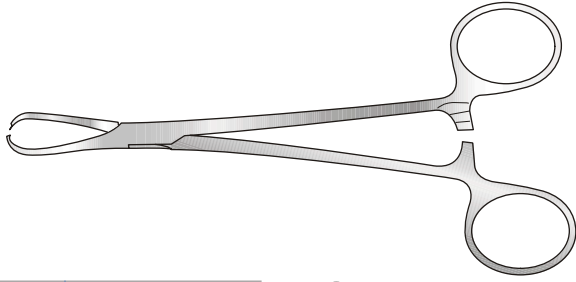

Code	Description
SI-GI/458	1-2 teeth, 178mm long



## Guys Gallabin Suture-Holding Forceps

Screw joint, angled flat blades

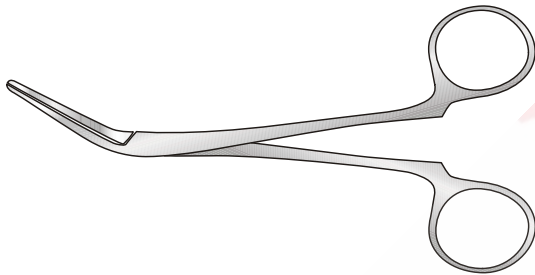

Code	Description
SI-GI/450	125mm long
SI-GI/4402	150mm long

## Russian Dissecting Forceps

With fenestrated end

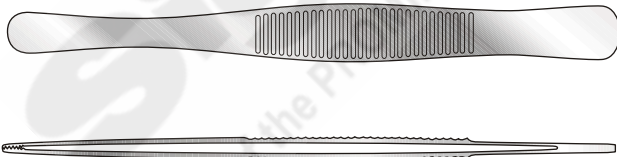

Code	Description
SI-GI/SH-5503b	150mm long
SI-GI/SH-5503	200mm long
SI-GI/403	230mm long
SI-GI/SH-5503a	250mm long



# Sponge Holding and Sterilising Forceps

## Rampley Sponge Holding Forceps

Box joint, straight, serrated jaws

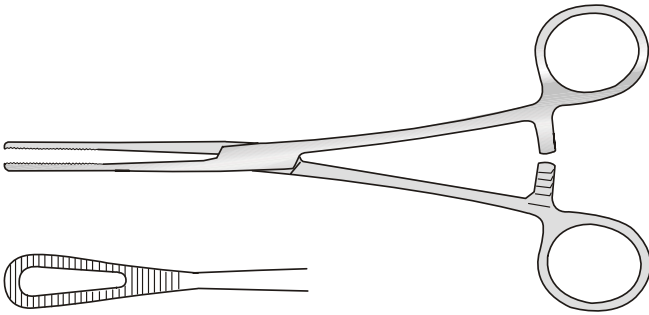

Code	Description
SI-GI/353	178mm long
SI-GI/354	241mm long

## Lister Sinus Forceps

Box joint, serrated tip

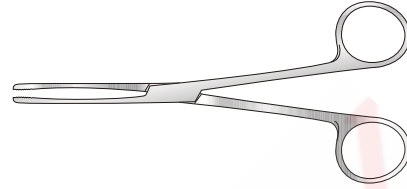

Code	Description
SI-GI/367	127mm long
SI-GI/368	152mm long
SI-GI/369	178mm long

## Foerster Sponge Holding Forceps

Box joint, straight, serrated jaws

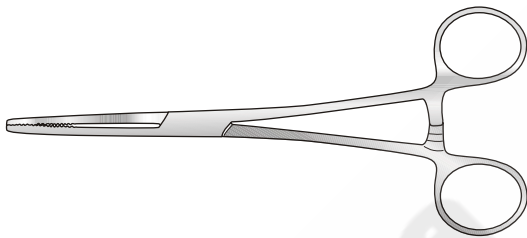

Code	Description
SI-GI/354a	178mm long

## Cheate Sterilizer Forceps

Screw joint

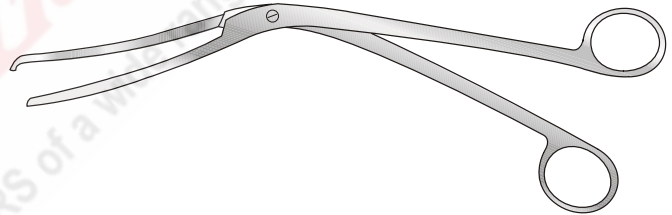

Code	Description
SI-GI/364	267mm long

## Harrison Bowl Steriliser Forceps

Screw joint, angled, double jaw

Code	Description
SI-GI/365	356mm long
SI-GI/366	457mm long

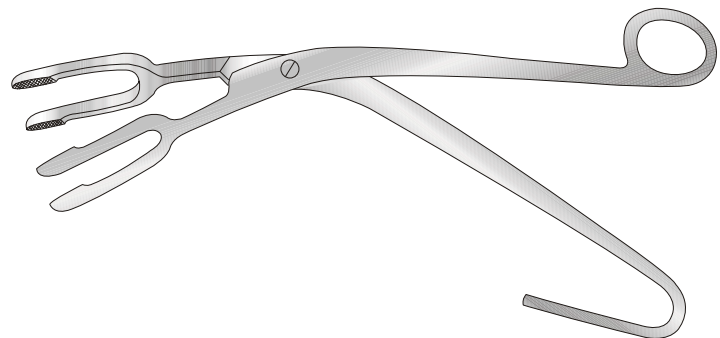

All images are indicative. Constant R & D may lead us to change the design for improvement

## Hunter Splinter Forceps

Serrated grooved pointed jaws



Code	Description
SI-GI/360	115mm long

## Michel Forceps

Box joint, double-ended, for inserting and removing clips stainless steel

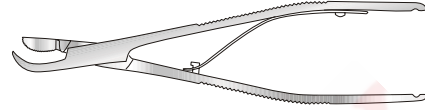

Code	Description
SI-GI/357	130mm long

## Michel Skin Holding Forceps

With magazine for Michel clips

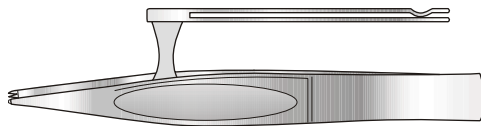

Code	Description
SI-GI/358	1-2 teeth, 127mm long

## Michel Clip Extracting Forceps

Box joint

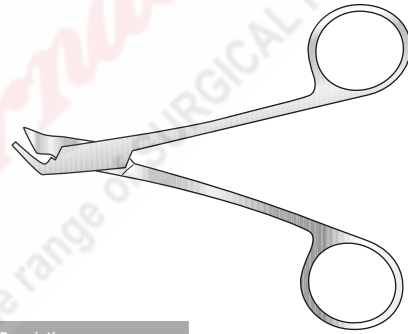

Code	Description
SI-GI/359	125mm long

## Childe Approximating Forceps

With magazine for Michel clips

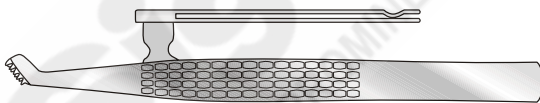

Code	Description
SI-GI/469	180mm long

## Robins Anchoring Forceps

140mm long

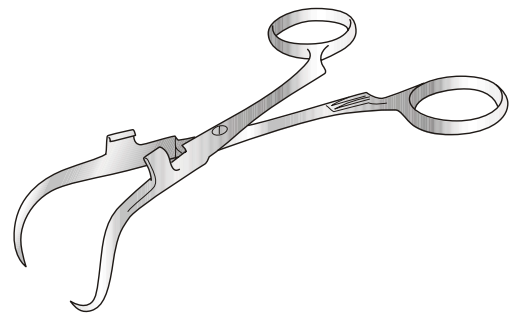

Code	Description
SI-GI/453	5mm with holder for diathermy leads
SI-GI/453a	13mm with holder for suction tubing

# Premium Quality Stainless Steel Scissors

## Dressing Scissors

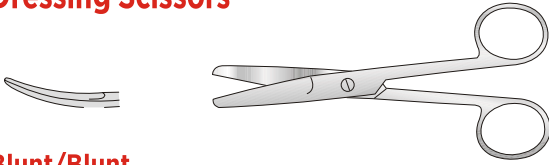

### Blunt/Blunt

#### Straight

Code	Description
SI-GI/133	130mm long
SI-GI/136	146mm long
SI-GI/139	165mm long

#### Curved

Code	Description
SI-GI/142	130mm long
SI-GI/143	146mm long
SI-GI/144	165mm long
SI-GI/145	185mm long
SI-GI/404	147mm long

With one serrated blade

## Metzenbaum Scissors

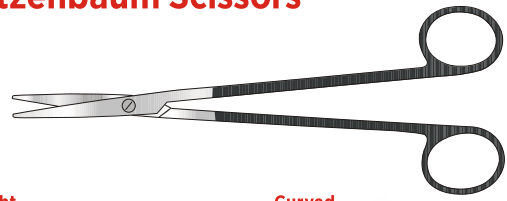

### Straight

Code	Description
SI-GI/405	180mm long
SI-GI/406	147mm long
SI-GI/406a	200mm long
SI-GI/406b	230mm long
SI-GI/406c	250mm long
SI-GI/406d	280mm long

### Curved

Code	Description
SI-GI/407	185mm long
SI-GI/408	147mm long
SI-GI/408a	200mm long
SI-GI/408b	230mm long
SI-GI/408c	250mm long
SI-GI/408d	280mm long

## Blunt/Sharp

### Straight

Code	Description
SI-GI/134	130mm long
SI-GI/137	146mm long
SI-GI/140	165mm long

## Sharp/Sharp

### Straight

Code	Description
SI-GI/135	130mm long
SI-GI/138	146mm long
SI-GI/141	165mm long

### Curved

Code	Description
SI-GI/146	130mm long

## Mayo Scissors



### Straight

Code	Description
SI-GI/409	140mm long
SI-GI/409a	160mm long
SI-GI/411	190mm long
SI-GI/411a	230mm long

### Curved

Code	Description
SI-GI/410	140mm long
SI-GI/410a	160mm long
SI-GI/412	190mm long
SI-GI/412a	230mm long

## Dressing Scissors, Left-Handed

With one black bow, 145mm long

### Blunt/Blunt

Code	Description
SI-GI/192	Straight
SI-GI/193	Curved

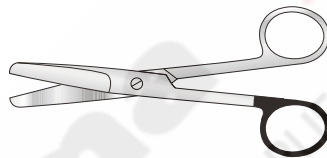

### Blunt/Sharp

Code	Description
SI-GI/194	Straight
SI-GI/195	Curved

### Sharp/Sharp

Code	Description
SI-GI/196	Straight
SI-GI/197	Curved

## Fergusson Scissors

Angled on flat

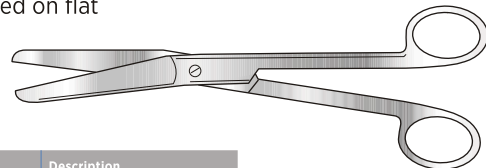

Code	Description
SI-GI/148	180mm long

## Littler Dissecting Scissors

Fine pattern, with eye for suture

Code	Description
SI-PL/001f	115mm long

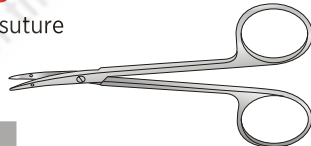

## Paynes Suture Scissors

Code	Description
SI-GI/152	100mm long

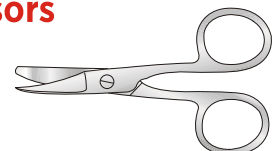

## Kilner Dissecting Scissors

Fine pattern

Code	Description
SI-PL/001a	115mm long



## Ligature Stitch Scissors

Fine pattern

Code	Description
SI-GI/153	115mm long

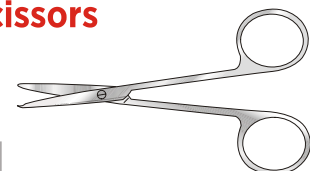

All images are indicative. Constant R & D may lead us to change the design for improvement

**Lister Bandage Scissors**

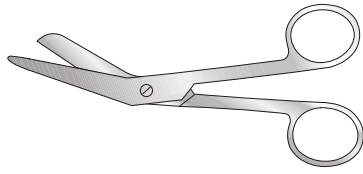

Code	Description
SI-GI/154	147mm long
SI-GI/155	178mm long

**Lister Bandage Scissors**

Angled, with probe end

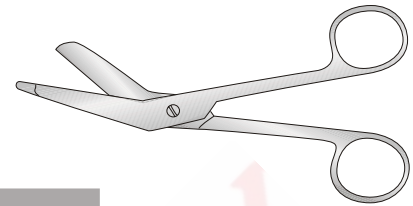

Code	Description
SI-GI/361	147mm long
SI-GI/362	178mm long

**McIndoe Scissors**

178mm long

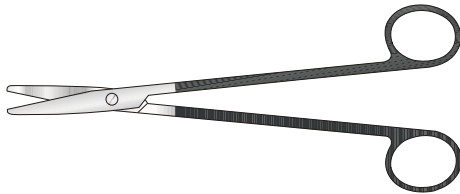

Code	Description
SI-GI/149	Straight
SI-GI/150	Curved on flat
SI-GI/150SI	Supercut, curved



**Thomas Strabismus Scissors**

114mm long

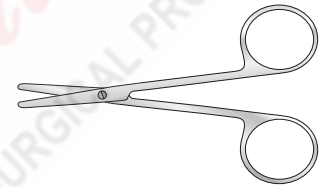

Code	Description
SI-OP/030	Straight
SI-OP/029	Curved

**Heath Stitch Scissors**

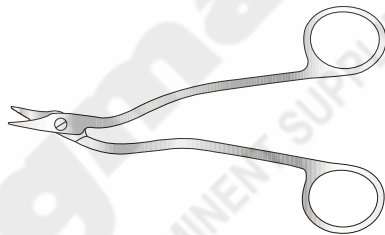

Code	Description
SI-GI/151	152mm long

**“Careless” Scissors**

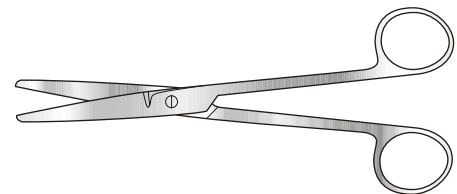

Code	Description
SI-GI/474	165mm long

**Tubing Scissors**

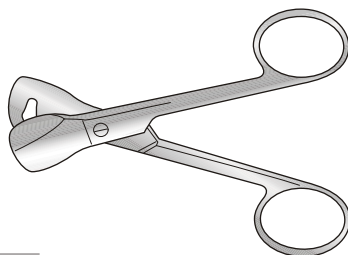

Code	Description
SI-GI/147	130mm long

**Utility Scissors**



Code	Description
SI-GI/466	190mm long

All images are indicative. Constant R & D may lead us to change the design for improvement

# Tungsten Carbide Hard Insert Scissors

## Dressing Scissors

Tungsten carbide hard insert,  
blunt/blunt

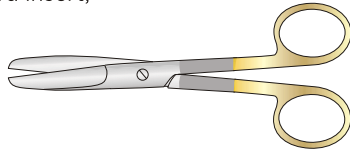

### Straight

Code	Description
SI-GI/430	130mm long
SI-GI/432	145mm long
SI-GI/434	165mm long
SI-GI/436	185mm long

### Curved

Code	Description
SI-GI/431	130mm long
SI-GI/433	145mm long
SI-GI/435	165mm long

## Mayo Dressing Scissors

Tungsten carbide hard insert

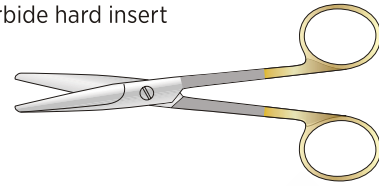

### Straight

Code	Description
SI-GI/419	140mm long
SI-GI/419a	160mm long
SI-GI/421	190mm long
SI-GI/421a	230mm long

### Curved

Code	Description
SI-GI/420	140mm long
SI-GI/420a	160mm long
SI-GI/422	190mm long
SI-GI/422a	230mm long

## Dressing Scissors

Tungsten carbide hard insert,  
blunt/sharp

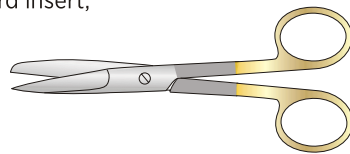

### Straight

Code	Description
SI-GI/423	130mm long
SI-GI/425	145mm long
SI-GI/427	165mm long
SI-GI/429	185mm long

### Curved

Code	Description
SI-GI/424	130mm long
SI-GI/426	145mm long
SI-GI/428	165mm long

## Mayo-Harrington Dressing Scissors

Tungsten carbide hard insert

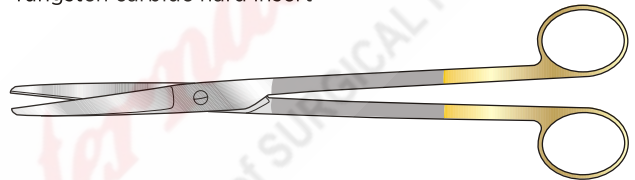

### 230mm long

Code	Description
SI-GI/417	Straight
SI-GI/418	Curved

### 200mm long

Code	Description
SI-GI/162a	Straight
SI-GI/413b	Curved

## Dressing Scissors

Tungsten carbide hard insert sharp/sharp

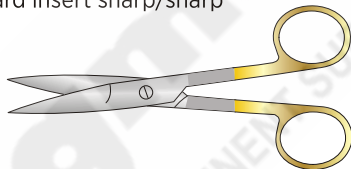

### Straight

Code	Description
SI-GI/437	130mm long
SI-GI/439	145mm long
SI-GI/441	165mm long
SI-GI/443	185mm long

### Curved

Code	Description
SI-GI/438	130mm long
SI-GI/440	145mm long
SI-GI/442	165mm long

## Metzenbaum Scissors

Tungsten carbide hard insert

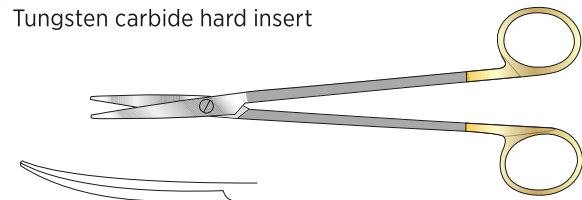

### 230mm long

Code	Description
SI-GI/445	145mm long
SI-GI/448	185mm long
SI-GI/471a	230mm long
SI-GI/471b	250mm long
SI-GI/471c	280mm long

### 200mm long

Code	Description
SI-GI/446	145mm long
SI-GI/449	185mm long
SI-GI/449a	200mm long
SI-GI/449b	230mm long
SI-GI/449c	250mm long
SI-GI/449d	280mm long

## Baby Metzenbaum Scissors

Tungsten carbide,  
hard insert, 145mm long

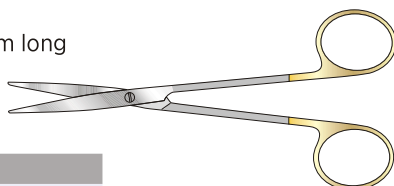

Code	Description
SI-GI/445a	Straight
SI-GI/446a	Curved

## Ligature Scissors

Tungsten carbide  
hard insert, curved

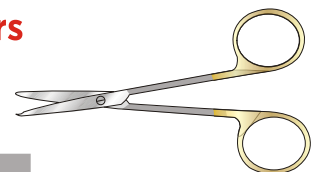

Code	Description
SI-GI/444	145mm long
SI-GI/447	185mm long

All images are indicative. Constant R & D may lead us to change the design for improvement

## Mayo Harrington Scissors

Supercut, tungsten carbide

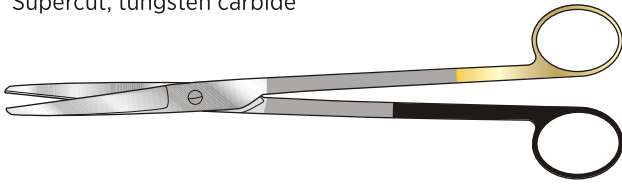

**230mm long**

Code	Description
SI-GI/162	Straight
SI-GI/413	Curved

**200mm long**

Code	Description
SI-GI/162b	Straight
SI-GI/413b	Curved

## Dressing Scissors

Supercut, tungsten carbide

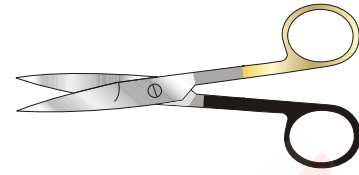

### Blunt/Blunt

**Straight**

Code	Description
SI-GI/174	130mm long
SI-GI/176	145mm long
SI-GI/178	165mm long
SI-GI/180	185mm long

**Curved**

Code	Description
SI-GI/175	130mm long
SI-GI/177	145mm long
SI-GI/179	165mm long
SI-GI/180a	185mm long

## Mayo Scissors

Supercut, tungsten carbide

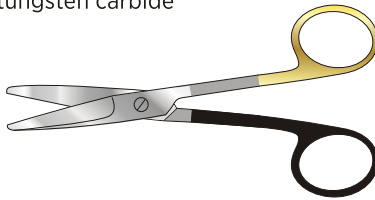

**Straight**

Code	Description
SI-GI/163	140mm long
SI-GI/163a	160mm long
SI-GI/165	190mm long
SI-GI/165a	230mm long

**Curved**

Code	Description
SI-GI/164	140mm long
SI-GI/164a	160mm long
SI-GI/166	190mm long
SI-GI/166a	230mm long

### Blunt/Sharp

**Straight**

Code	Description
SI-GI/167	130mm long
SI-GI/169	145mm long
SI-GI/171	165mm long
SI-GI/173	185mm long

**Curved**

Code	Description
SI-GI/168	130mm long
SI-GI/170	145mm long
SI-GI/172	165mm long
SI-GI/173a	185mm long

### Sharp/Sharp

**Straight**

Code	Description
SI-GI/181	130mm long
SI-GI/183	145mm long
SI-GI/185	165mm long
SI-GI/187	185mm long

**Curved**

Code	Description
SI-GI/182	130mm long
SI-GI/184	145mm long
SI-GI/186	165mm long
SI-GI/187a	185mm long

## Metzenbaum Dissecting Scissors

Supercut, tungsten carbide

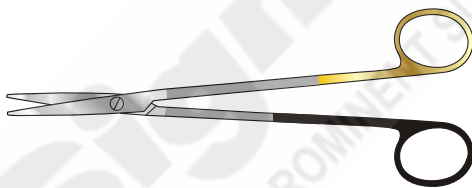

**Straight**

Code	Description
SI-GI/188tc	185mm long
SI-GI/188tca	200mm long
SI-GI/188tcb	230mm long
SI-GI/188tcc	250mm long
SI-GI/188tcd	280mm long

**Curved**

Code	Description
SI-GI/191tc	147mm
SI-GI/189tc	185mm
SI-GI/186tca	200mm
SI-GI/188tcb	230mm
SI-GI/188tcc	250mm
SI-GI/188tcd	280mm

# Supercut Operating Scissors

## Dressing Scissors

Supercut, blunt/blunt

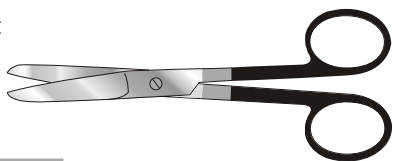

145mm long

Code	Description
SI-GI/160	Straight
SI-GI/161	Curved

## Dressing Scissors

Supercut, blunt/sharp

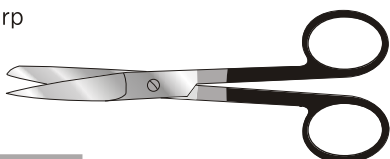

145mm long

Code	Description
SI-GI/156	Straight
SI-GI/157	Curved

## Dressing Scissors

Supercut, sharp/sharp



145mm long

Code	Description
SI-GI/158	Straight
SI-GI/159	Curved

## Mayo Scissors

Supercut

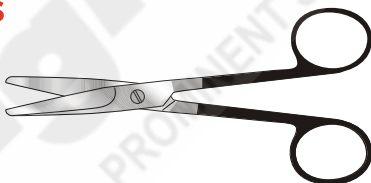

**Straight**

Code	Description
SI-GI/166a	140mm long
SI-GI/166e	160mm long
SI-GI/166b	170mm long

**Curved**

Code	Description
SI-GI/166c	140mm long
SI-GI/166f	160mm long
SI-GI/166d	170mm long

## Boyd Scissors

Supercut, blunt/blunt

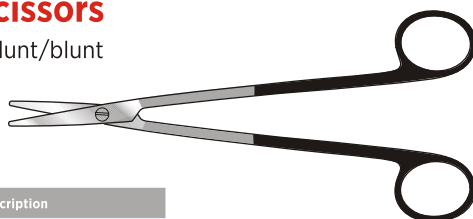

Code	Description
SI-THO/047	180mm long

## Metzenbaum Dissecting Scissors

Supercut

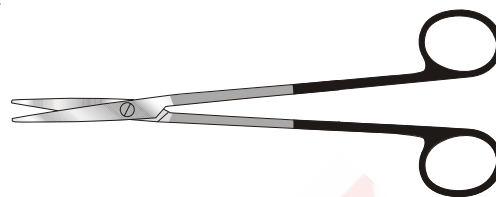

**Straight (length)**

Code	Description
SI-GI/190	147mm
SI-GI/188	185mm
SI-GI/188a	200mm
SI-GI/188b	230mm
SI-GI/188c	250mm
SI-GI/188d	280mm

**Curved (length)**

Code	Description
SI-GI/191	147mm
SI-GI/189	185mm
SI-GI/186a	200mm
SI-GI/186b	230mm
SI-GI/186c	250mm
SI-GI/186d	280mm

## Stevens Tenotomy Scissors

Supercut



**Curved/blunt**

Code	Description
SI-OP/424	114mm long
SI-OP/424a	125mm long
SI-OP/424gb	135mm long

**Curved/sharp**

Code	Description
SI-OP/425	114mm long
SI-OP/425a	140mm long
SI-OP/425b	160mm long

**With cutout, 110mm long**

Code	Description
SI-OP/426	Straight/blunt, 114mm long
SI-OP/427	Straight/sharp, 114mm long
SI-OP/427c	Straight/sharp, 180mm long

Code	Description
SI-OP/427a	Straight/blunt
SI-OP/427b	Curved/blunt

## Strabismus Scissors

Supercut

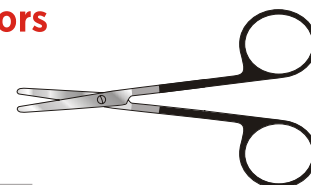

114mm long

Code	Description
SI-GI/475	Straight
SI-GI/475a	Curved

## Iris Scissors

Supercut



114mm long

Code	Description
SI-OP/476	Straight
SI-OP/476a	Curved

All images are indicative. Constant R & D may lead us to change the design for improvement



## Bruce Clarke Needle Holder

Screw joint

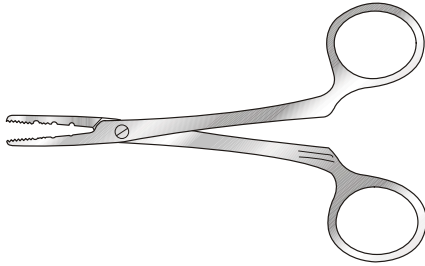

Code	Description
SI-GI/205	127mm long

## Lawrence Needle Holder

Fine jaw, 150mm long

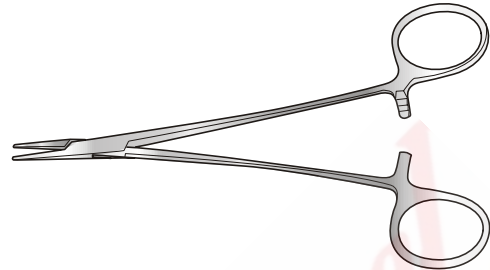

Code	Description
SI-PL/012a	
SI-PL/012b	Tungsten carbide jaw

## Crile-Wood Needle Holder

Straight, baby, fine

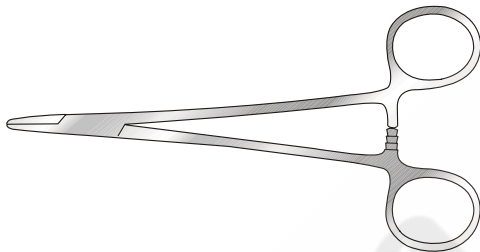

Code	Description
SI-GI/199	150mm long

## Needle Holder

Surgical Holdings pattern, box joint, lightweight, with curved plain jaws and one offset bow for thumb

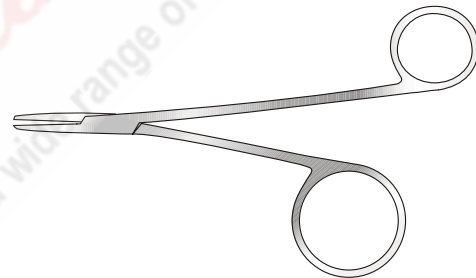

Code	Description
SI-GI/209	152mm long

## Kilner Needle Holder

Box joint, cross-serrated jaw

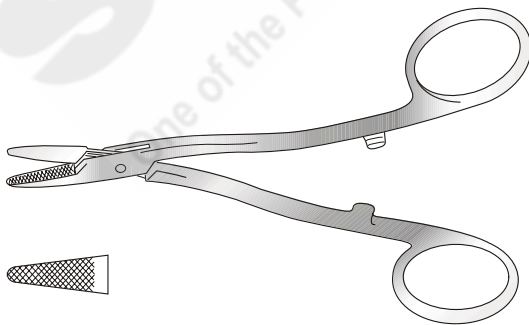

Code	Description
SI-GI/200	165mm long
SI-GI/201	133mm long

## MacPhail Needle Holder

Screw joint, with one copper jaw

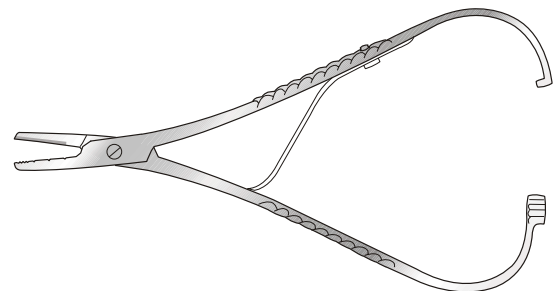

Code	Description
SI-GI/206	159mm long
SI-GI/207	178mm long
SI-GI/208	209mm long

All images are indicative. Constant R & D may lead us to change the design for improvement

# Needle Holders

## Mathieu Needle Holder

Screw joint

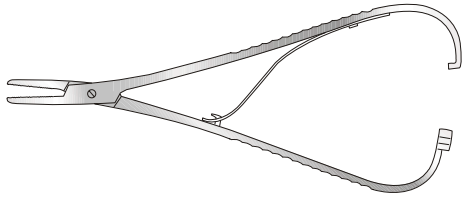

Code	Description
SI-GI/210	172mm long
SI-GI/211	209mm long
SI-GI/212	243mm long

## Naughton Morgan Needle Holder

Box joints, cross serrated jaws

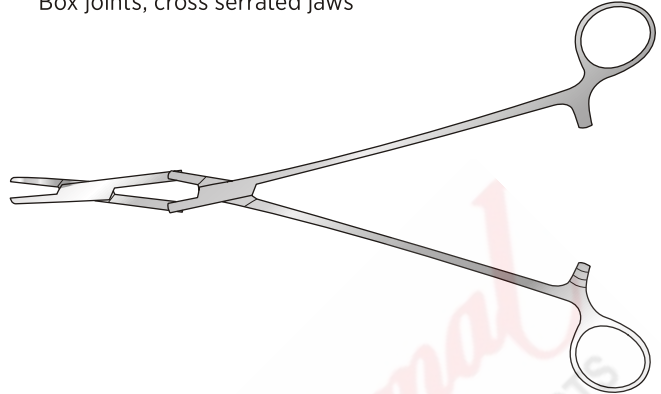

## Mayo Needle Holder

Box joint, straight

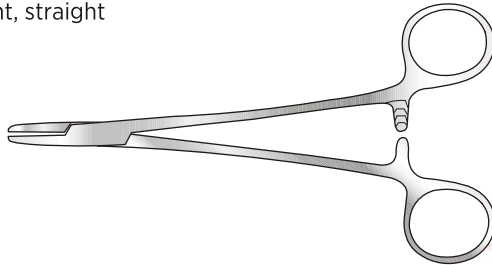

### Wide cross serrated jaws

Code	Description
SI-GI/224	159mm long
SI-GI/398	203mm long

### Narrow cross serrated jaws

Code	Description
SI-GI/225	159mm long

### Tungsten carbide

Code	Description
SI-GI/399	185mm long
SI-GI/400	254mm long

Code	Description
SI-GI/401	185mm long
SI-GI/402	254mm long

## Rochester-Mayo Needle Holder

Screw joint

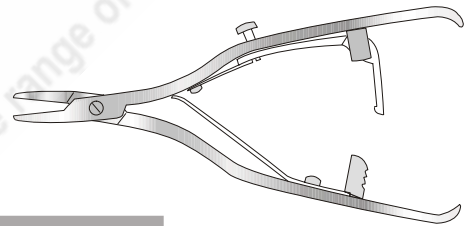

Code	Description
SI-GI/213	178mm long

## Berry Needle Holder/Wire Twister

Tungsten carbide jaws

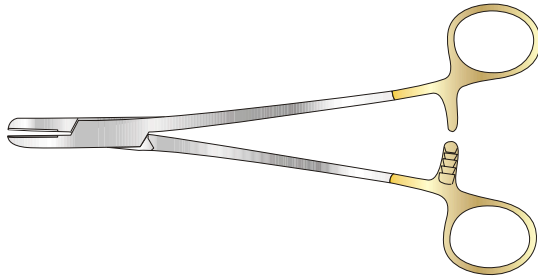

Code	Description
SI-GI/467	200mm long

## Finochietto Needle Holder

Tungsten carbide jaws

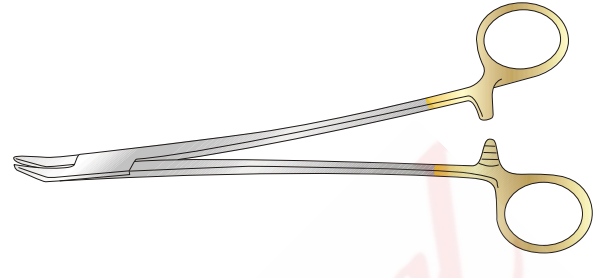

Code	Description
SI-GI/222	215mm long
SI-GI/223	265mm long

## Crile-Wood Needle Holder

Tungsten carbide insert, box joint, satin finish, straight



Code	Description
SI-GI/217	159mm long
SI-GI/218	178mm long
SI-GI/198	150mm long

## Halsey Needle Holder

Tungsten carbide insert, box joint, satin finish, straight

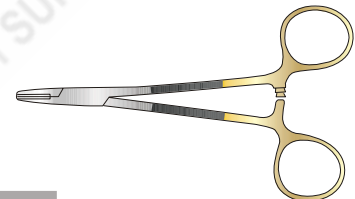

Code	Description
SI-GI/220	127mm long

## Derf Needle Holder

Tungsten carbide insert



Code	Description
SI-GI/BUPHF002	115mm long

## Kilner Needle Holder

Tungsten carbide insert

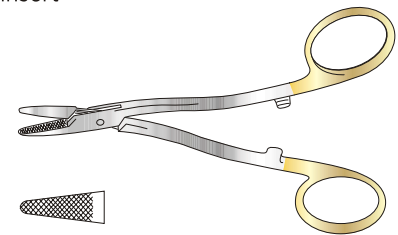

Code	Description
SI-GI/221	140mm long

# Tungsten Carbide Needle Holders

## Masing Needle Holder

Tungsten carbide insert, one angled bow

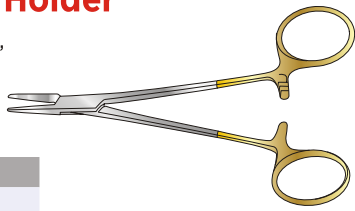

Code	Description
SI-GI/009R	130mm long

## Ryder Needle Holder

Tungsten carbide insert, box joint, satin finish, straight

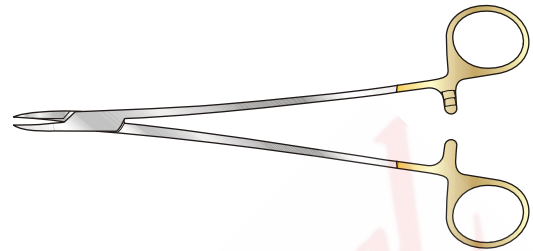

## Nievert Needle Holder

Tungsten carbide insert, box joint, satin finish, straight

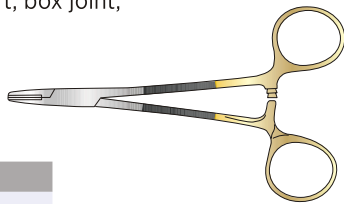

Code	Description
SI-GI/219	127mm long

### 0.2mm jaw pitch

Code	Description
SI-GI/SH-5197a	135mm long
SI-GI/SH-5197b	155mm long
SI-GI/SH-5197c	175mm long
SI-GI/SH-5197d	210mm long

### 0.4mm jaw pitch

Code	Description
SI-GI/SH-5198a	135mm long
SI-GI/SH-5198b	155mm long
SI-GI/SH-5198c	175mm long
SI-GI/SH-5198d	210mm long

## DeBakey Needle Holder

250mm long

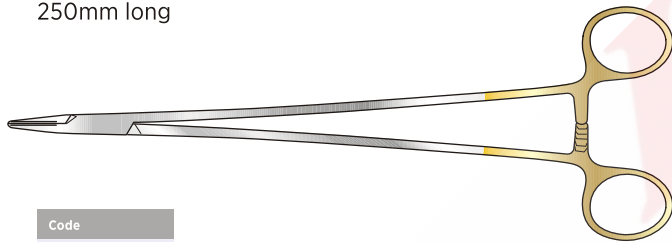

Code
THO/SI-5642a

## Sarot Needle Holder

Diamond jaw, tungsten carbide, gold plated bows

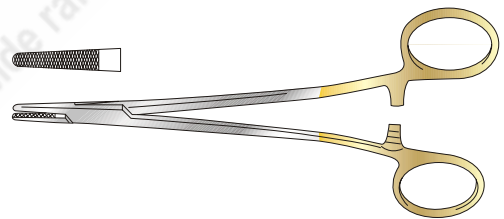

Code	Description
SI-GI/451	181mm long

## Tungsten Carbide Needle Holders

### Features and Benefits

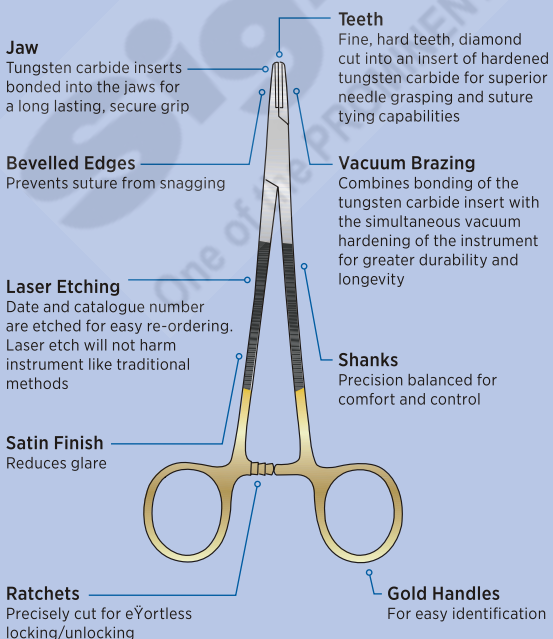

## Mayo-Hegar Needle Holder

Tungsten carbide insert, box joint, satin finish, straight

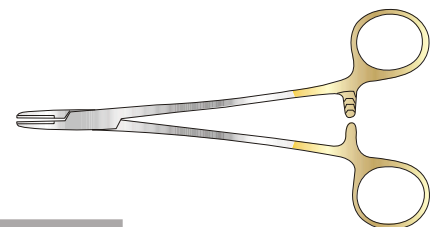

Code	Description
SI-GI/472	130mm long
SI-GI/214	159mm long
SI-GI/215	178mm long
SI-GI/216	209mm long

LONGER SIZES AVAILABLE

All images are indicative. Constant R & D may lead us to change the design for improvement

## Olsen-Hegar Scissor/Needle Holder

With tungsten carbide insert

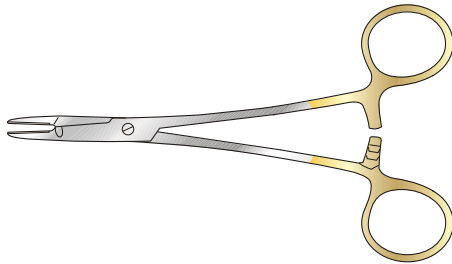

Code	Description
SI-GI/229	147mm long
SI-GI/230	165mm long

## Olsen-Hegar Scissor/Needle Holder

Screw joint

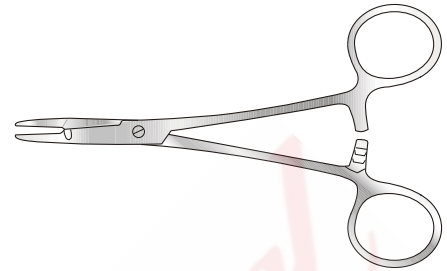

Code	Description
SI-GI/226	140mm long
SI-GI/227	165mm long
SI-GI/228	190mm long

## Gillies Scissor/Needle Holder

Right-hand, with tungsten carbide insert

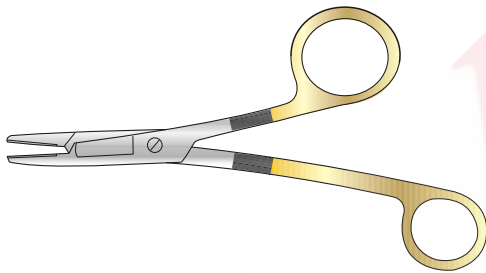

Code	Description
SI-GI/235	158mm long

## Gillies Scissor/Needle Holder

Heavy pattern, 158mm long



Code	Description
SI-GI/233	Right-hand
SI-GI/234	Left-hand

## Gillies Scissor/Needle Holder

158mm long

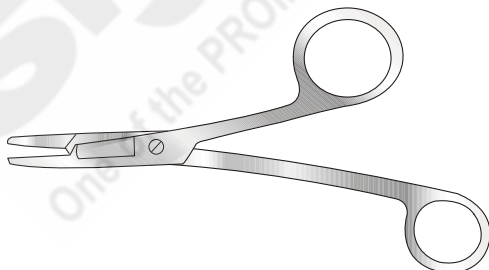

Code	Description
SI-GI/231	Right-hand
SI-GI/232	Left-hand

## Foster Gillies Scissor/Needle Holder

Fine pattern

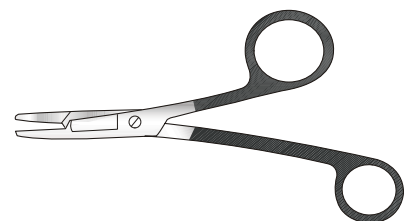

Code	Description
SI-GI/236	127mm long

All images are indicative. Constant R & D may lead us to change the design for improvement

# Bag and Towel Clips

## Spring Clip

Serrated pattern, stainless steel, for fixing slings to leg splints, also for towel clipping

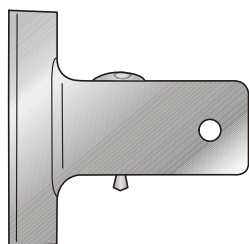

Code	Description
SI-GI/344	63mm wide

## Spring Bag Clip

Serrated

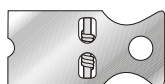

Code	Description
SI-GI/345	26mm wide

## Jones Towel Clip

Superior quality spring forcep type

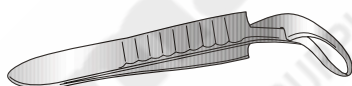

Code	Description
SI-GI/346	89mm long

## Shardles Towel Clip

Spring curved, cross action

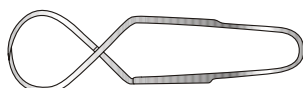

Code	Description
SI-GI/347	77mm long

## Backhaus Towel Clip

Superior quality, box joint

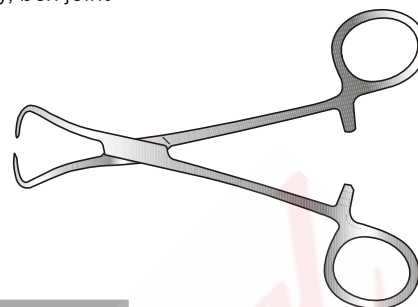

Code	Description
SI-GI/348	89mm long
SI-GI/348a	102mm long
SI-GI/349	130mm long

## Moynihhan Towel Clip

Screw joint, 2-2 teeth, for sides of incision

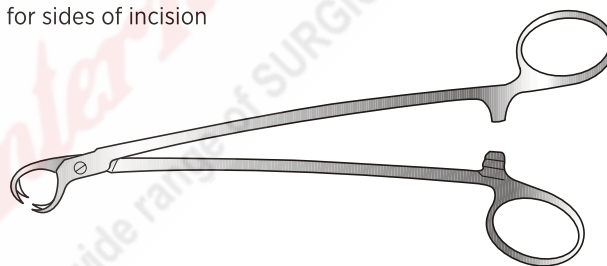

Code	Description
SI-GI/470	191mm long

## Ball and Socket Towel Forceps

Box joint

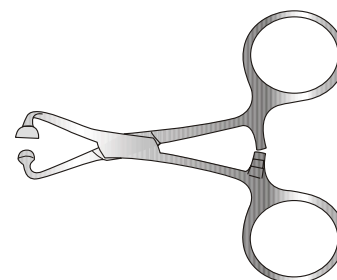

Code	Description
SI-GI/350	89mm long
SI-GI/351	115mm long
SI-GI/352	140mm long

**Goligher Retractor**

Complete with 2 centre blades:  
1 x 90mm wide x 50mm deep  
1 x 90mm wide x 90mm deep

and 2 pairs of lateral blades:  
1 pair 25mm wide x 45mm deep  
1 pair 50mm wide x 90mm deep

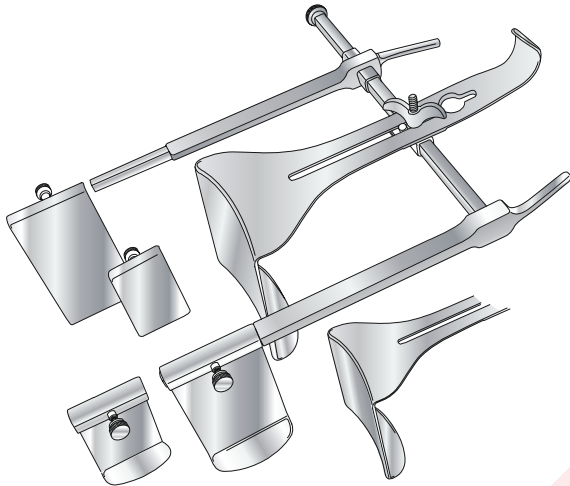

Code
SI-GI/305

**Balfour Abdominal Retractor**

Trivalve, frame 203mm

**Child**

102mm opening, 51mm deep lateral blades,  
38mm deep centre blade

**Adult**

178mm opening, 64mm deep lateral blades,  
44mm deep centre blade

**Extra large**

178mm opening, 102mm deep lateral blades,  
108mm deep centre blade

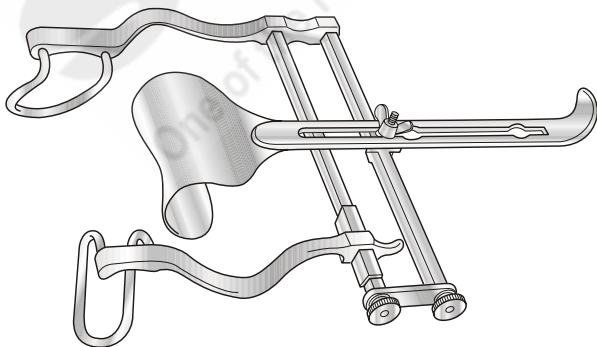

Code	Description
SI-GI/373	Child
SI-GI/374	Adult
SI-GI/375	Extra large

**Miles Retractor**

Complete with 2 centre blades:  
1 x 90mm wide x 50mm deep  
1 x 90mm wide x 75mm deep

and 2 pairs of lateral blades:  
1 pair 80mm wide x 35mm deep  
1 pair 80mm wide x 75mm deep

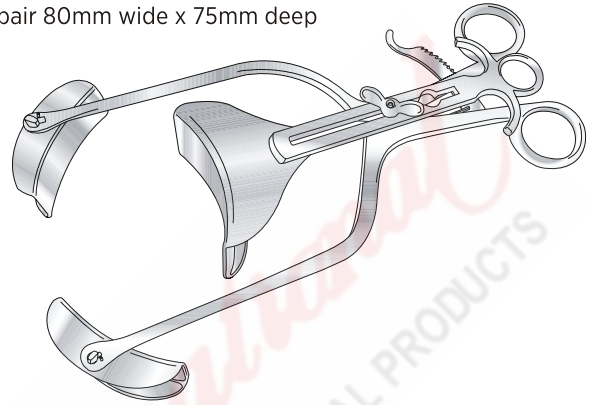

Code	Description
SI-GI/376	340mm long

**OTHER BLADE SIZES AVAILABLE**

**Balfour Abdominal Retractor**

Bivalve, baby

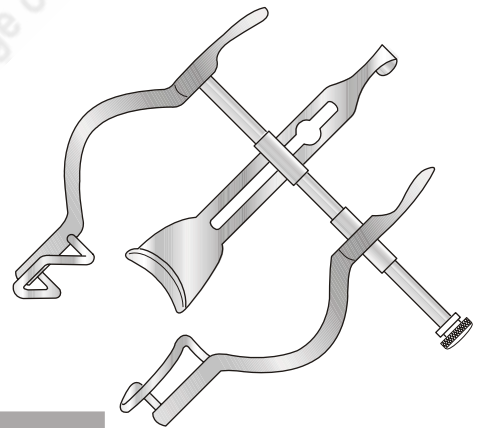

Code	Description
SI-GI/372	Fully open 89mm

**Berkeley Abdominal Retractor**

Parallel action

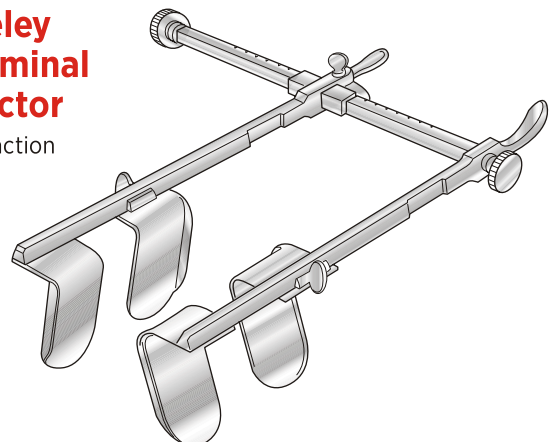

Code	Description
SI-GI/461	Blades 35mm x 60mm deep, 215mm long

All images are indicative. Constant R & D may lead us to change the design for improvement

# Retractors

## Collin Retractor

110mm fully open, 235mm long

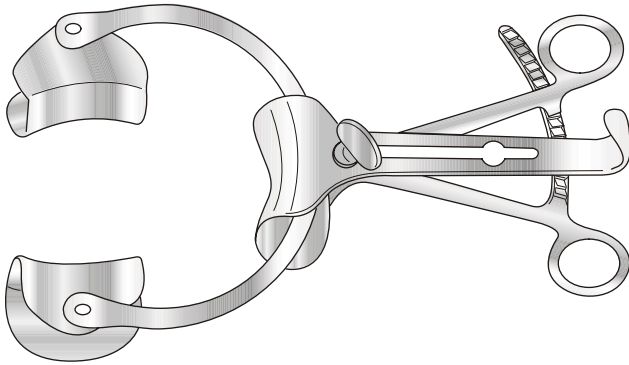

Code	Description
SI-GI/322	Complete with centre blade 55 x 40mm and one pair of blades 38mm x 60mm
SI-GI/322a	Without centre blade

## Joll Thyroid Retractor

Self retaining, with lock-in nut

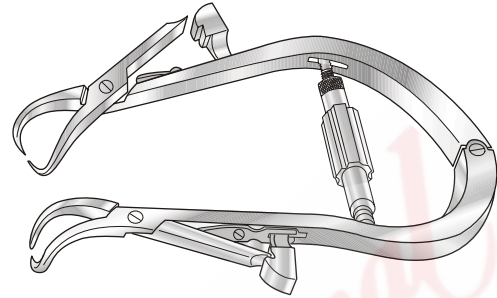

Code	Description
SI-GI/363	152mm long

## Gelpi Retractor

Self retaining

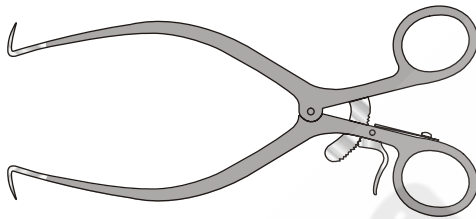

Code	Description
SI-GY/013a	140mm long
SI-GY/013b	178mm long

## Gossett Abdominal Retractor

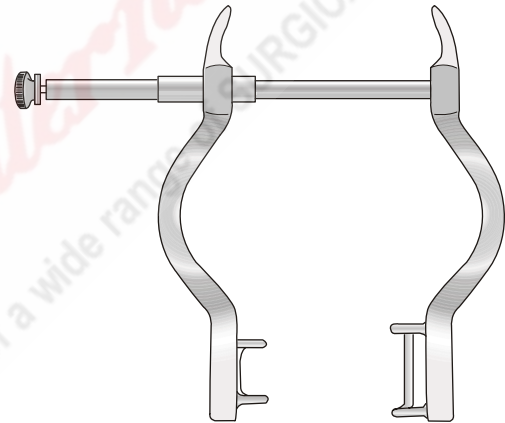

Code	Description
SI-GI/303	Large, fully open 185mm long
SI-GI/304	Small, fully open 95mm long

## Pozzi Abdominal Retractors

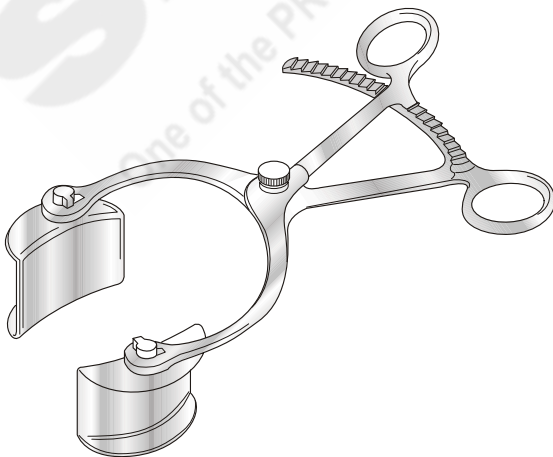

Code	Description
SI-GI/370	Swivel blades: 38 x 60mm, bivalve, 254mm long

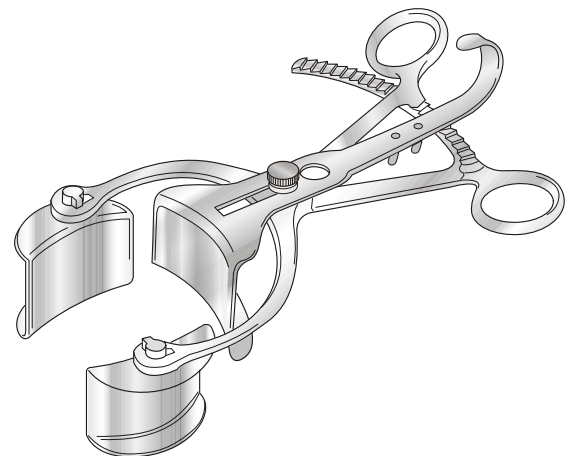

Code	Description
SI-GI/371	Swivel blades: 38 x 59mm, trivalve, 203mm long

All images are indicative. Constant R & D may lead us to change the design for improvement



## Bowlby Dilator

Curved

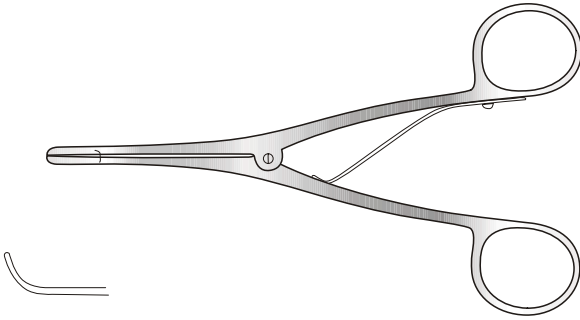

Code	Description
SI-GI/495	145mm long

## Travers Retractor

Self retaining with internal rack, 210mm long

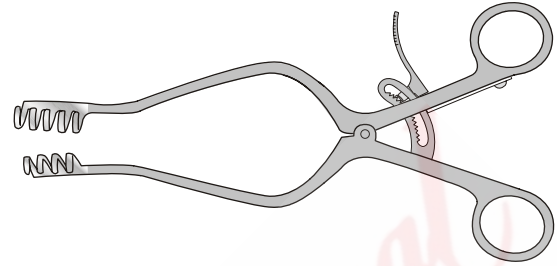

Code	Description
SI-GI/323	4 x 5 teeth, 95mm fully open

## Irwin Retractor

Self retaining, with cam rack, 4 x 4 teeth

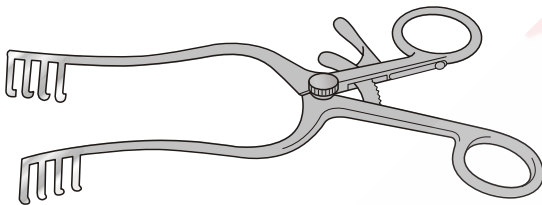

Code	Description
SI-GI/324	178mm long

## West Retractor

Self retaining, 140mm long

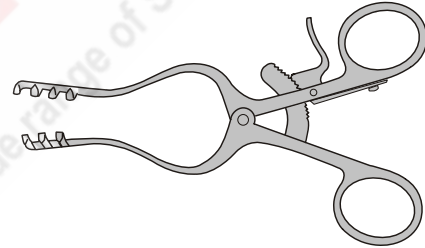

Code	Description
SI-GI/326	3 x 4 teeth, 60mm fully open
SI-GI/326cr	3 x 4 teeth, 60mm fully open, with cam rack

## Norfolk and Norwich Retractor

4 x 5 teeth 50mm blades x 223mm long

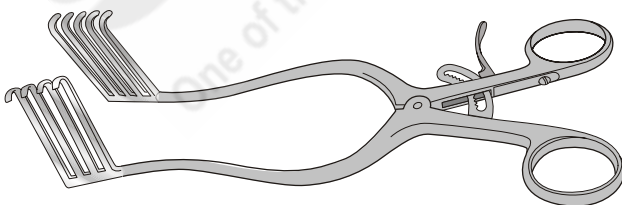

Code	Description
SI-GI/325	Standard rack

## Weitlander Retractor

3-4 teeth

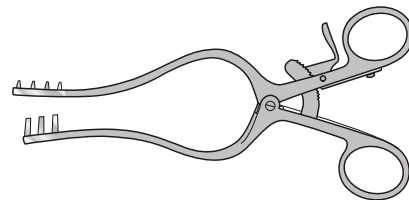

**135mm long**

Code	Description
SI-GI/496	Blunt
SI-GI/496a	Sharp
SI-GI/496b	Sharp, 2-3 teeth
SI-GI/496c	Blunt, 2-3 teeth

**165mm long**

Code	Description
SI-GI/497	Blunt
SI-GI/497a	Sharp

All images are indicative. Constant R & D may lead us to change the design for improvement

# Retractors

## Kocher Retractor

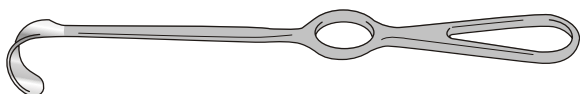

230mm long

Code	Description
SI-GI/378	36 x 20mm blade

250mm long

Code	Description
SI-GI/378a	67 x 25mm blade
SI-GI/378b	80 x 42mm blade
SI-GI/378c	80 x 50mm blade
SI-GI/378d	80 x 60mm blade

## Canny Ryall Navy Retractor

Double-ended, with one single hook blade 5mm wide, and one fenestrated blade

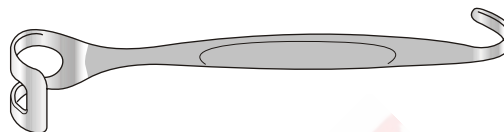

Code	Description
SI-GI/343	Fenestrated blade 16mm wide, 190mm long
SI-GI/343a	Fenestrated blade 19mm wide, 190mm long
SI-GI/343b	Fenestrated blade 25mm wide, 220mm long
SI-GI/343c	Fenestrated blade 30mm wide, 220mm long

## Kocher Langenbeck Retractor

215mm long

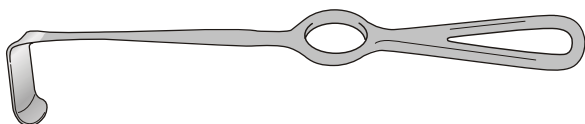

Code	Description
SI-GI/336sp	25 x 6mm blade
SI-GI/379a	35 x 8mm blade
SI-GI/379b	35 x 11mm blade
SI-GI/379c	35 x 15mm blade
SI-GI/357sp	41 x 11mm blade

Code	Description
SI-THO/cutsp015	55 x 11mm blade
SI-GI/379d	70 x 15mm blade
SI-GI/379e	80 x 12mm blade
SI-GI/379f	80 x 16mm blade

## Canny Ryall Army Retractor

Double prong, 13mm wide, 165mm long



Code	Description
SI-GI/342	Large, 19mm wide
SI-GI/342a	Small, 11mm wide



## Langenbeck Retractor

Single ended



Code	Description
SI-GI/336	Blade 22mm x 6mm
SI-GI/337	Blade 45mm x 13mm
SI-GI/337a	Blade 65mm x 13mm
SI-GI/338a	Blade 75mm x 25mm
SI-GI/338a1	Blade 65mm x 25mm

## Czerny Retractor

Double ended

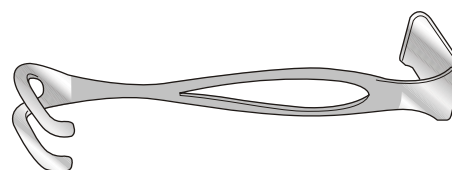

Code	Description
SI-GI/341	171mm long

## Landon Retractor

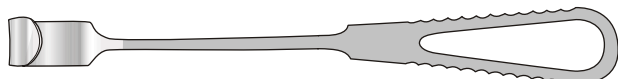

Code	Description
SI-GI/494	230mm



## Lane Retractor

Double ended blade, 229mm long

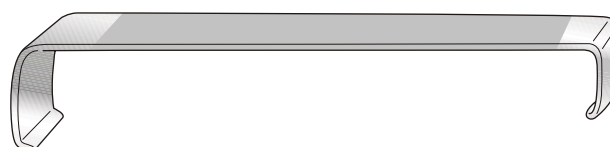

Code	Description
SI-GI/339	13mm x 19mm wide
SI-GI/340	25mm x 32mm wide

All images are indicative. Constant R & D may lead us to change the design for improvement

## Morris Retractor

Single blade, 229mm long

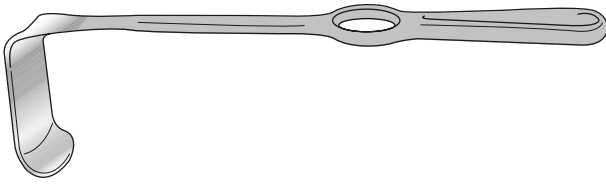

Code	Description
SI-GI/330	38 x 51mm
SI-GI/331	51 x 51mm
SI-GI/332	64 x 51mm

## Morris Retractor

Double ended, 216mm long

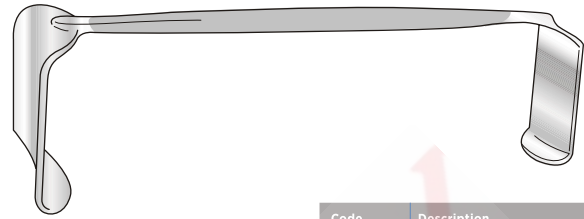

Code	Description
SI-GI/327	32 x 51mm and 38 x 51mm
SI-GI/328	44 x 51mm and 51 x 51mm
SI-GI/329	64 x 51mm and 38 x 51mm

## Moynihan Retractor

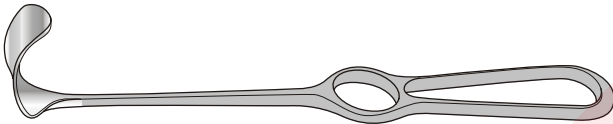

Code	Description
SI-GI/462	Single ended, blade 13 x 22mm, 215mm long

## Deaver Abdominal Retractors



Code	Description
SI-GI/306	Set of 5, 315mm overall length
SI-GI/307	25mm wide
SI-GI/308	25mm wide
SI-GI/309	38mm wide
SI-GI/310	51mm wide
SI-GI/311	76mm wide

## Elliot (Modified Deaver) Retractor

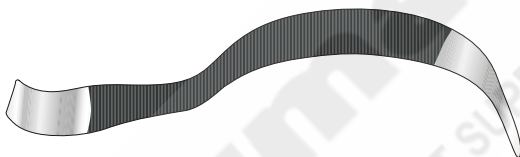

Code	Description
SI-GI/308M	With flat handle

## Dyball and Lock Retractor

For liver

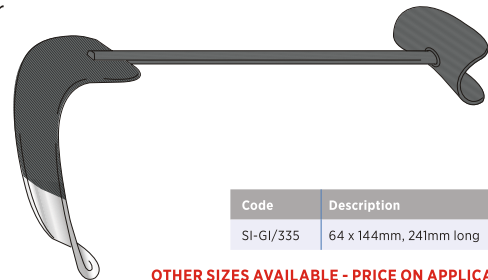

Code	Description
SI-GI/335	64 x 144mm, 241mm long

OTHER SIZES AVAILABLE - PRICE ON APPLICATION

## Deaver Abdominal Retractors

With round handles

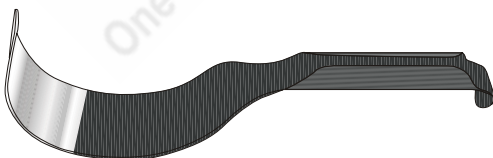

Code	Description
SI-GI/312	Set of 5, 305mm overall length
SI-GI/313	25mm wide
SI-GI/314	25mm wide
SI-GI/315	38mm wide
SI-GI/316	51mm wide
SI-GI/317	76mm wide

## Kelly Retractor Blade

267mm long



Code	Description
SI-GI/333	38 x 191mm
SI-GI/334	57 x 191mm

All images are indicative. Constant R & D may lead us to change the design for improvement

# Retractors

## Durham Retractor

With fenestrated blade, 216mm long

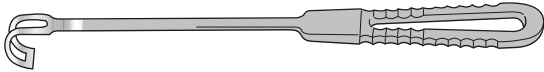

Code	Description
SI-GI/300	10mm wide
SI-GI/301	14mm wide
SI-GI/302	20mm wide

## Kocher Retractor

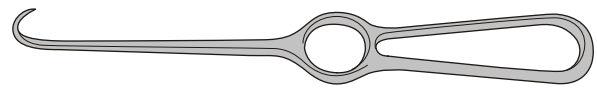

Code	Description
SI-OR/N036c	Sharp, 205mm long
SI-OR/N036	Sharp, 220mm long
SI-OR/N036b	Blunt, 220mm long

## Ballance (Volkman) Retractor

203mm long

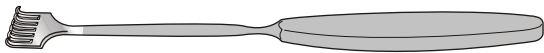

### Sharp

Code	Description
SI-GI/463	1 prong
SI-GI/463a	2 prong
SI-GI/463b	3 prong
SI-GI/463c	4 prong
SI-GI/463d	6 prong

### Blunt

Code	Description
SI-GI/463e	1 prong
SI-GI/463f	2 prong
SI-GI/463g	3 prong
SI-GI/463h	4 prong
SI-GI/463i	6 prong

## Senn-Miller Retractor

170mm long



Code
SI-SH/5881

## Single Hook Retractor

Sharp



Code	Description
SI-GI/SH5671	152mm long
SI-PL/065b	Half size, fine

## Volkman Retractor



Code	Description
SI-OR/400	Sharp, 220mm long
SI-OR/400a	Blunt, 220mm long
SI-OR/400b	Sharp, 245mm long

## Gillies Skin Hook

Solid handle, 190mm long



Code	Description
SI-PL/065a	Standard, fine
SI-PL/065b	Half size, fine

## Kilner Retractor

Double ended, cat's paw



Code	Description
SI-PL/056	152mm long

## MacDonald Dissector Double Ended



Code	Description
SI-GI/285	191mm long

## Probe, Sinus Silver



Code	Description
SI-GI/464	152mm long

## Brodie Director Probe Ended, Silver Plated



Code	Description
SI-GI/286	165mm long

## Probe, Fish Tail Silver Plated



Code	Description
SI-GI/293	127mm long
SI-GI/294	152mm long
SI-GI/295	203mm long
SI-GI/296	254mm long

## Watson Cheyne Dissector

Fine, double-ended, with probe end



Code	Description
SI-GI/287	127mm long
SI-GI/288	191mm long
SI-GI/288a	230mm long
SI-GI/288b	255mm long

## Jobson Horne Probe Dressing (Aural)

With one flat tapered end, serrated edge and one small ring end, stainless steel



Code	Description
SI-GI/297	140mm long
SI-GI/298	178mm long

## Probe, Malleable Silver Plated



Code	Description
SI-GI/289a	127mm long
SI-GI/289	152mm long
SI-GI/290	178mm long
SI-GI/291	203mm long
SI-GI/292	255mm long
SI-GI/292a	305mm long

## Kidney Dish

Stainless steel

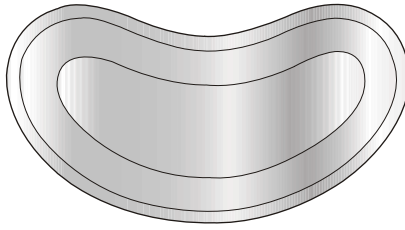

Code	Description
SI-GI/380	152mm
SI-GI/381	203mm
SI-GI/382	254mm
SI-GI/383	305mm

## Cheate Jar

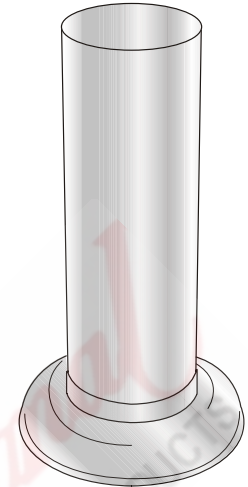

Code	Description
SI-GI/397	Stainless steel, 203mm x 50mm

## Lotion Bowl

Without lid, stainless steel

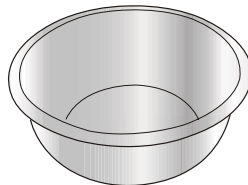

Code	Description
SI-GI/384	102mm
SI-GI/385	152mm
SI-GI/386	203mm
SI-GI/387	254mm
SI-GI/388	305mm

## Measuring Jug

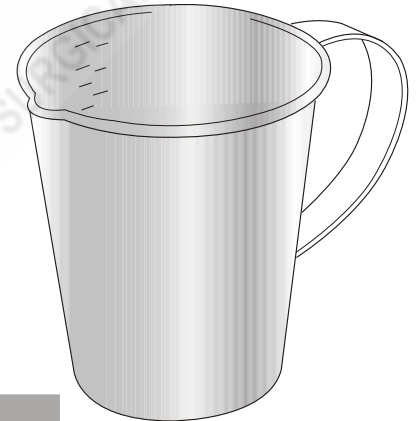

Code	Description
SI-GI/395	1 litre capacity

## Instrument Tray

Stainless steel

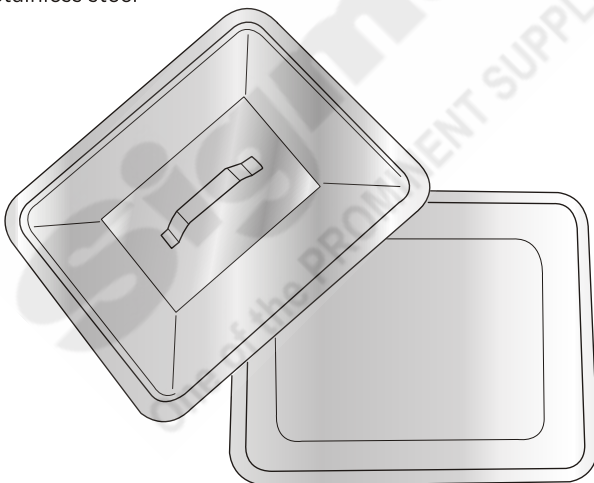

Code	Description
SI-GI/389	254 x 203 x 50mm
SI-GI/390	Lid only for 254 x 203 x 50mm
SI-GI/391	305 x 254 x 50mm
SI-GI/392	Lid only for 305 x 254 x 50mm
SI-GI/393	356 x 305 x 50mm
SI-GI/394	Lid only for 356 x 305 x 50mm

## Petri Dish



Code	Description
SI-SH/002149	100mm, stainless steel, with lid

## Gallipot

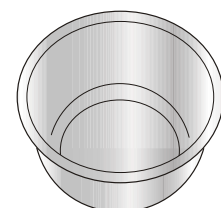

Code	Description
SI-GI/396	Stainless steel, 63mm

All images are indicative. Constant R & D may lead us to change the design for improvement